



Shenzhen Youth Green Lighting Technology Co.,LTD.

Email: sales01@youthgreenled.com; Web: www.youthgreenled.com



5 years warranty

130 LM/W

Product Catalog

LED AREA LIGHT III

— Motion Sensor /PIR sensor Photocell —



Growth stems from innovation, development depends on quality

● Product Description

- Motion Sensor /PIR sensor, Photocell
- Beam Angle: Type II, Type III, Type IV, Type V
- Material and color (optional)
- LEDs: SMD2835
- Efficacy: 130LM/W
- AC120V-277V or 277V-480V
- 0/1-10V dimmable
- Temperature: -40°F-113°F(-40°C to 45°C)
- PF>0.90, CRI >80
- IP 66
- 5 years warranty



● Dimensions

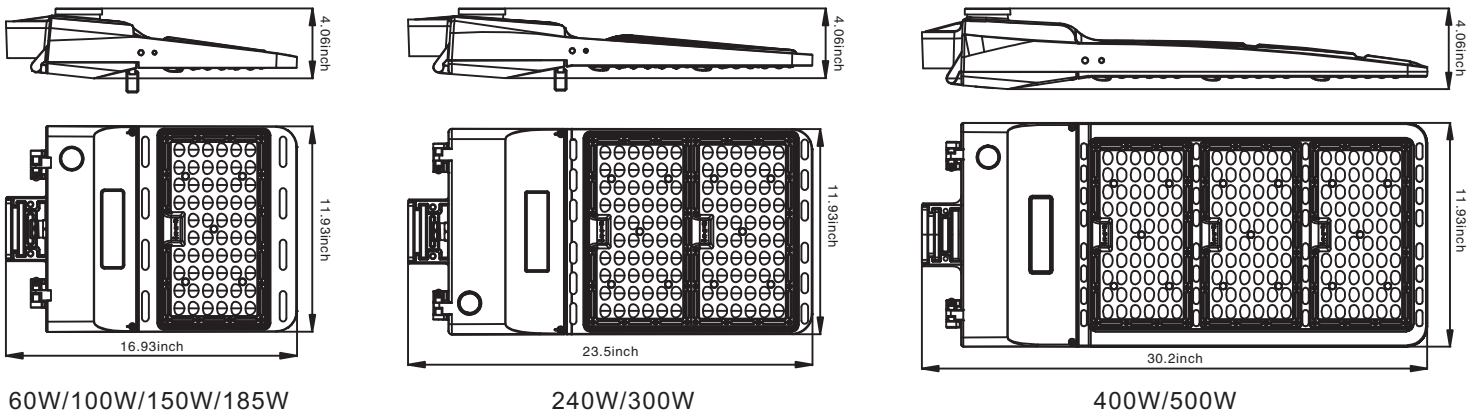

● Accessories (optional)



● Structure

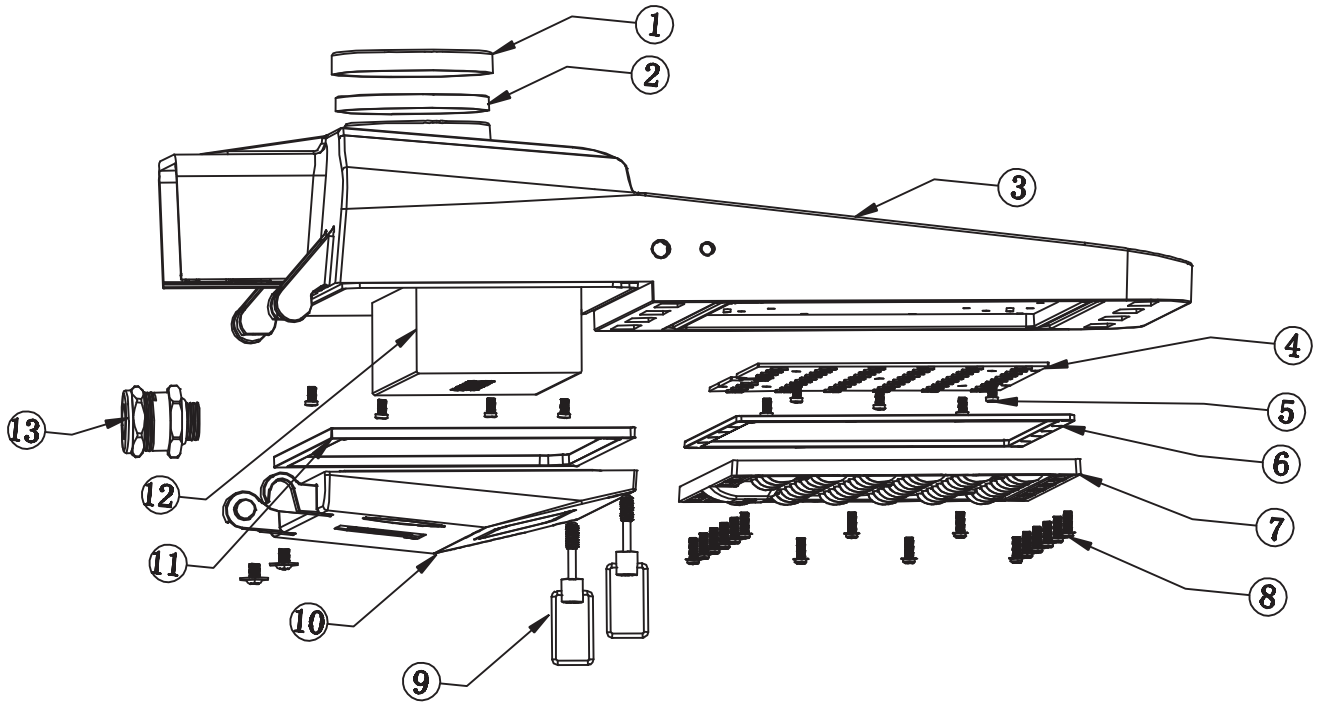

- | | |
|-------------------------------|---|
| 1. Sensitive cover | 8. Lens screw |
| 2. Sensitive cover silica gel | 9. LED driver compartment screws |
| 3. Radiator | 10. LED driver compartment cover |
| 4. Light source module | 11. Silicone for LED driver compartment |
| 5. Aluminum base plate screws | 12. LED driver |
| 6. Lens silicone | 13. Waterproof screws |
| 7. Lens | |

● Applications



● Luminaire Photometric Test Report

60WUL 3500K

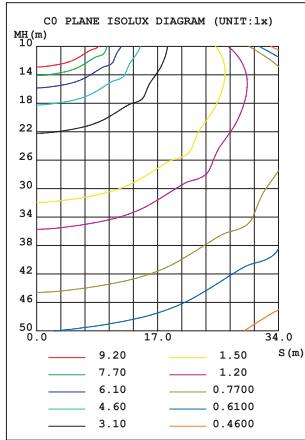
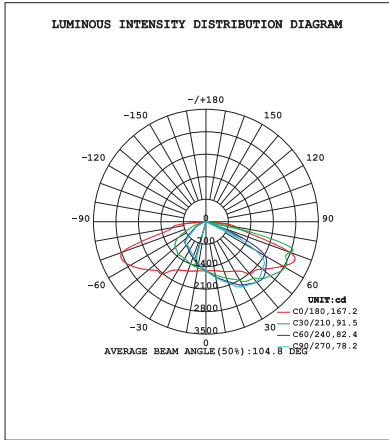

100WUL 3500K

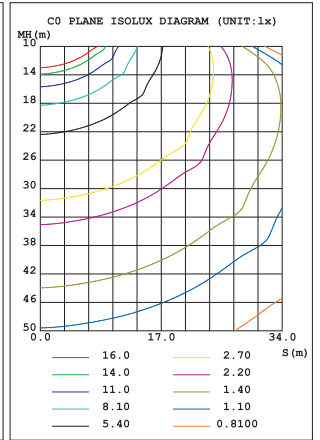
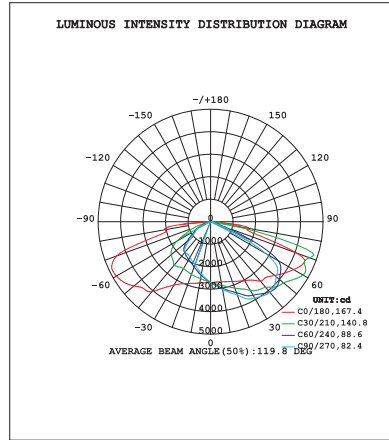

240WUL 3500K

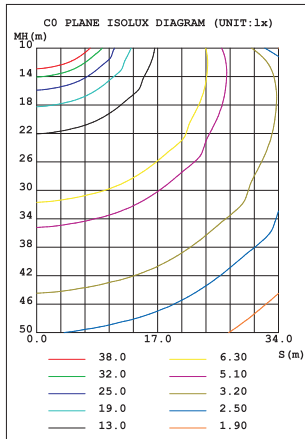
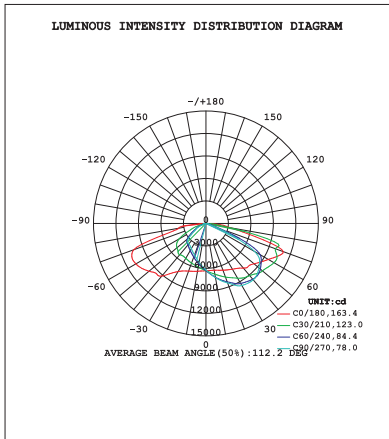

300WUL 3500K

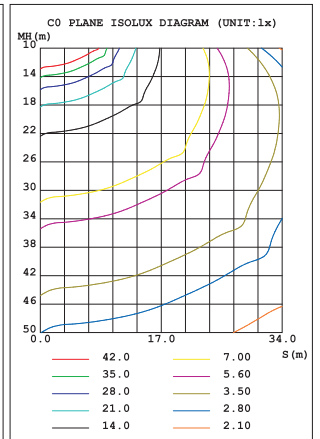
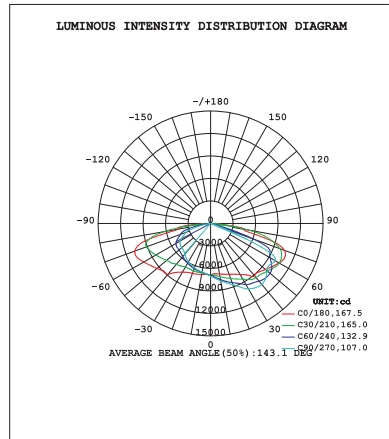

400WUL 3500K

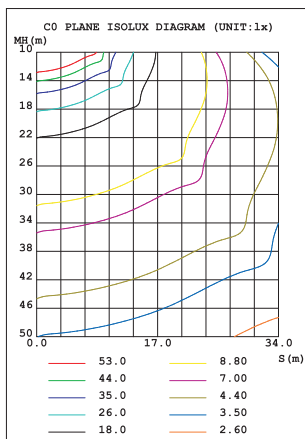
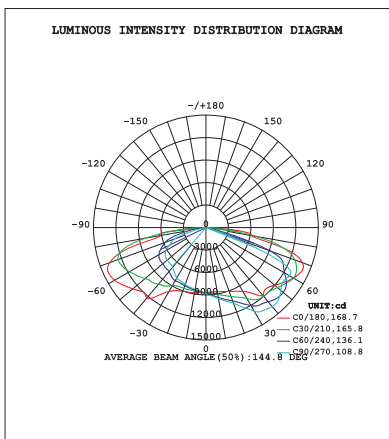

500WUL 3500K

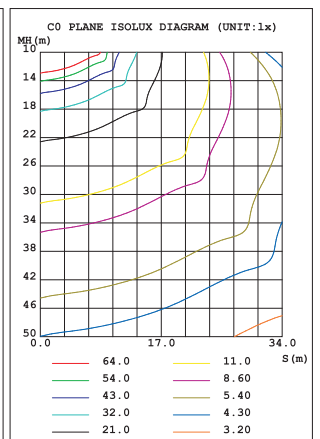
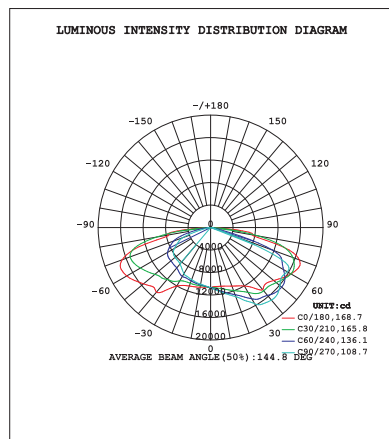

● Ordering information

Parameter

Model No.	Watts (W)	Input Voltage	Efficacy	CCT (K)	Size (inch)	N.W (lbs)	
YG043PK60-S-3C-DM	60	AC120-277V or AC277-480V	130LM/W	3000 3500 4000	16.93*11.93*4.06	8.07	
YG043PK100-S-3C-DM	100					8.84	
YG043PK150-S-3C-DM	150					8.95	
YG043PK185-S-3C-DM	185			8.95			
YG043WK240-S-3C-DM	240			5000	23.6*11.93*4.06	15.48	
YG043WK300-S-3C-DM	300			5700		15.58	
YG043bK400-S-3C-DM	400					30.2*11.93*4.06	22.27
YG043bK500-S-3C-DM	500						22.27

PS:EEE=

DM	Dimming function	SD	Dimming+Sensing function
L/H	L: AC120-277V H: AC277-480V		
CCT=3000K / 3500K / 4000K / 5000K / 5700K			

● Installation Guide

SLIP FITTER BRACKET

sold separately:

1. Remove the circular plate from the slip fitter (2 screws).
2. Thread the wire through the slip fitter into the pole. Make AC connections in accordance to wiring diagram.
3. If necessary adjust the fixture angle with the large hex bolt on the side of the slip fitter.

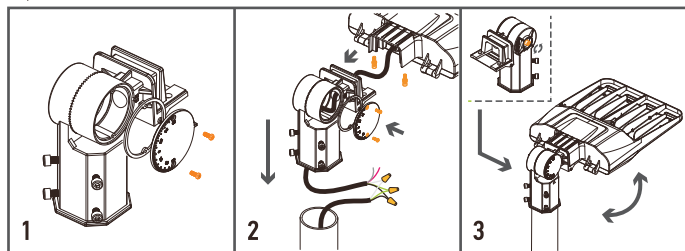

The wiring is inside the pole, the side is sealed with a rubber ring and fixed with screws, preventing water from getting inside the fixture.

ARM MOUNTING BRACKET

sold separately:

1. Open up the door on the arm bracket (1 screw). Install the mounting arm onto the pole (2 bolts). Make sure the silicone gaskets form a tight seal. Choose gasket depending on form of the pole (round or flat).
2. Thread the cord from the fixture through the bracket into the pole and tighten the two M8 screws on the body of the light.
3. Pass the AC wire through the base and tighten the two screws on the body of the fixture.

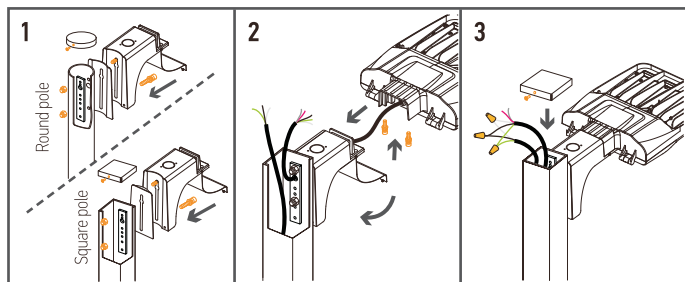

PHOTOCELL

sold separately:

1. Power off before installation. Use a screwdriver to take off the circular plate (2 screws). Screw the photocell base on the top of the fixture, pull the wires through the driver box.
2. Use a screwdriver to open the driver box (2 screws). Connect the wires Black to Black, White to White and Red to Load.
3. Firmly place the photocell into the receptacle base and twist it clockwise until it locks into place.

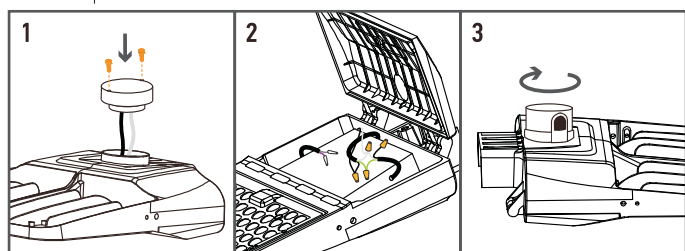

FLOODLIGHT MOUNTING BRACKET

sold separately:

1. Drill holes on the mounting surface corresponding to the holes in the arm. Attach fixture to bracket with 2 screws and bracket to surface with 2 screws.
2. Wire in accordance to the wiring schematic.
3. Seal the connections with the back plate of the fixture. Adjust fixture angle as needed.

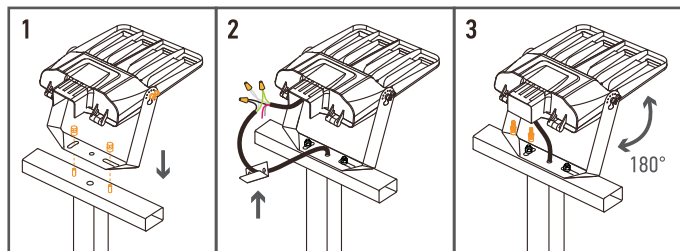

ARM MOUNTING BRACKET with angle adjustment

sold separately:

1. Open up the door on the arm bracket (1 screw). Install the mounting arm onto the pole (2 bolts). Make sure the silicone gaskets form a tight seal. Choose gasket depending on form of the pole (round or flat).
2. Thread the cord from the fixture through the bracket into the pole and tighten the two M8 screws on the body of the light.
3. Pass the AC wire through the base and tighten the two screws on the body of the fixture. If necessary adjust the fixture angle with the large hex bolt on the side of the bracket.

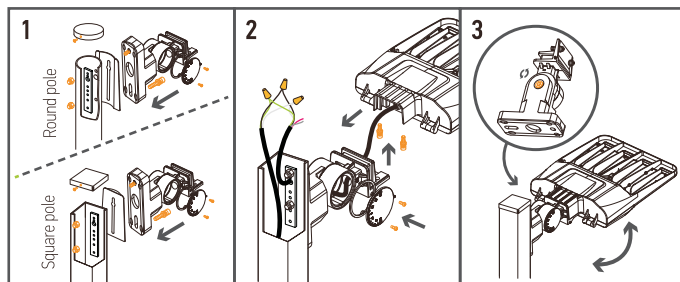

FULL TRUNNION MOUNTING BRACKET

sold separately:

1. Drill holes on the mounting surface, size corresponding to the holes on the arm. Fix the bracket on the wall with screws. Pull wires through mount, secure fixture to the bracket.
2. Wire the AC power into the water tight junction box as shown in the wiring schematic diagram. Adjust the screw position to get desired angle when necessary.

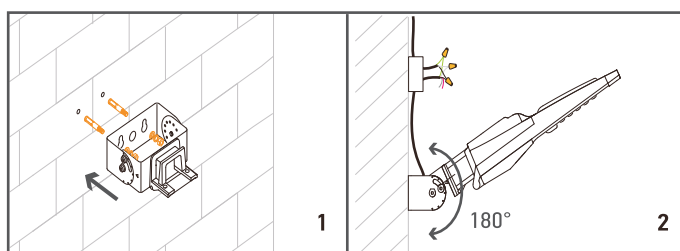

Please read these instructions completely and carefully before installation

WARNING

- Turn power off before inspection, installation or removal.
- Properly ground electrical enclosure.
- Follow all NEC and local codes.
- Use only UL or IEC approved wire for input/output connections.

Prepare Electrical Wiring

Electrical Requirements

The LED driver must be supplied with AC120-277V or AC277-480V, 50/60 Hz per product label and connected to an individual properly grounded branch circuit, protected by a 15 or 20 ampere circuit breaker.

Grounding Instructions

The grounding and bonding of the overall system shall be done in accordance with National Electric Code (NEC) Article 600 and local codes.

Announcements:

1. This equipment is a professional installation. Non-professional personnel shall not remove or install the equipment.
2. To avoid damage, falling, electric shock or fire, please do not modify the lamp or replace accessories without confirming with the supplier.
3. Maintenance/installation and replacement the lamps, please confirm to cut off the power supply, and the lamps have set up a cooling. Please make sure the lamps have been properly installed before processing power.
4. Ensure the accurate and reliable connection.
5. Ensure that the product around the vent, the lamp cannot violate any fire.